

Eliteboard

User Guide

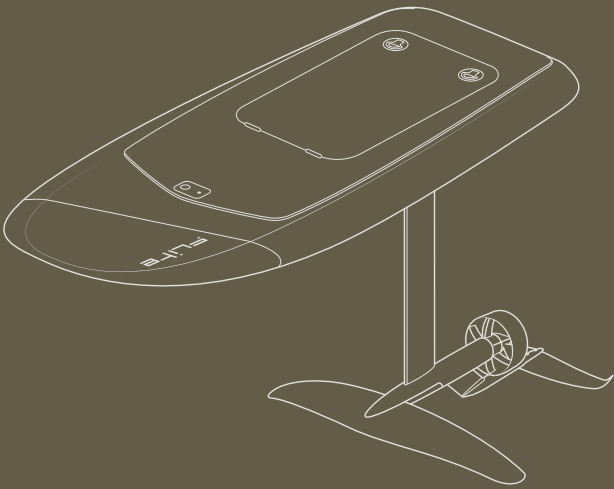

Important

IN ORDER TO OPERATE THE PRODUCT CORRECTLY AND MINIMISE THE CHANCES OF DAMAGE, SERIOUS INJURY OR DEATH, IT IS ESSENTIAL TO READ AND FOLLOW ALL OF THE INSTRUCTIONS AND WARNINGS IN THE USER GUIDE PRIOR TO ASSEMBLY, SETUP OR USE. BY USING A FLITEBOARD YOU AGREE THAT YOU DO SO AT YOUR OWN RISK.



For the latest version of this guide visit

support.fliteboard.com



Watch our video tutorials at

fliteboard.com/video



Authorised Flite Service, Resellers and Fliteschools

fliteboard.com/locations



Download Flite APP from App Store
IOS only, V10.7 or higher

apps.apple.com/au/app/fliteboard/id1499441319



Watch our Flite APP update video

tinyurl.com/yb3vudw8



Post-storage checklist

tinyurl.com/y7vw5brg



Material Safety Data Sheets

tinyurl.com/yczdbueu



Fliteboard support

support.fliteboard.com



Fliteboard contact

fliteboard.com/contact

Important rider safety

1 Read the manual and watch the how to Fliteboard video

Before attempting to Fliteboard for the first time, read this manual and pay special attention to the warnings and disclaimers. Most injuries can be avoided by using proper technique when learning. Watch the how to Fliteboard video at <https://fliteboard.com/videos>



2 Wear a helmet and PFD

Wear an approved and certified helmet and PFD (Personal Flotation Device) at all times.

There may be specific rules and legal requirements in your location that also apply.



3 Avoid contact with the wings and propeller

Avoid contact with the wings, mast and propeller which all have sharp edges. Take care to not kick the wings when climbing on to the board.

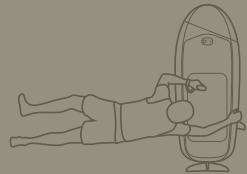

4 Keep distance

Keep well clear of other water users at all times. Check regulations for vessel operating distance rules in your area. Always be on the look out for swimmers, other vessels or obstacles when riding which may be obscured by waves or glare.



5 Release the throttle

Release the trigger immediately on committing yourself to a fall. This will stop the propeller and reduce the forces which could otherwise lead to a more extreme crash. Practice this skill when learning with the goal of stopping the propeller before you hit the water in a fall.

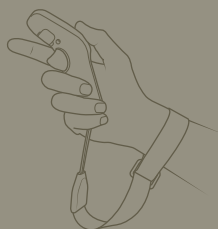

6 Fall away from Fliteboard

The best way to avoid injury is to practice the correct falling technique. As soon as you begin to lose balance, purposely fall in the direction the board is already falling. You will then likely end up in the water on the opposite side to the hydrofoil assembly. Like being on stilts - it is impossible to regain balance once your weight is no longer above the hydrofoil wings (unless you are turning).

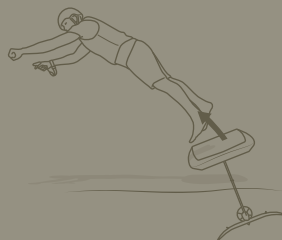

What's in the box

You will receive your Fliteboard in three separate shipment packages.

Box 1: Fliteboard

Within the included padded board bag you will find either Fliteboard, Fliteboard PRO or Fliteboard AIR (depending upon your choice)

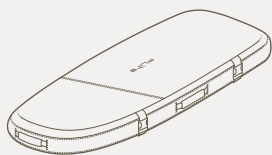

Fliteboard PRO travel bag

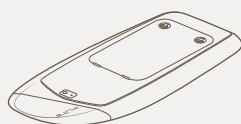

Fliteboard PRO

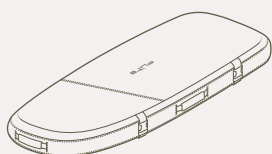

Fliteboard travel bag

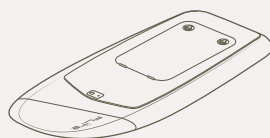

Fliteboard

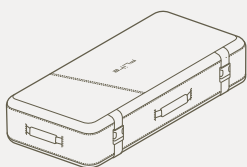

Fliteboard AIR travel bag

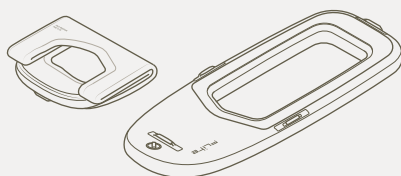

Fliteboard AIR

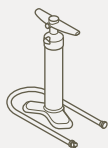

Fliteboard AIR pump and hose

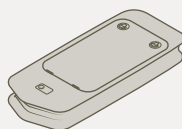

Fliteboard AIR core

Box 2: Flitecell



Flitecell travel case

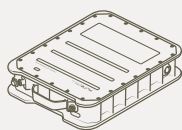

Flitecell Explore



Flitecell Sport travel case

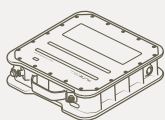

Flitecell Sport

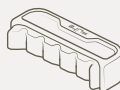

Flitecell Sport spacer

Box 3: Flite eFoil travel bag

Within the included travel case you will find the following components:



eFoil travel bag

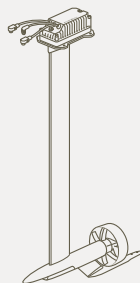

eFoil system including:

- Flitebox
- Flite propulsion system
- Fuselage tail

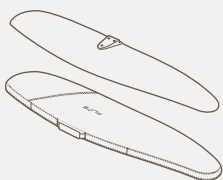

XL Wing
+ cover

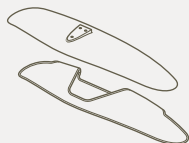

Cruiser Wing
+ cover

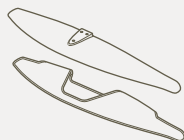

Flyer Wing
+ cover



Rear XL Stabiliser Wing
+ cover



Rear Stabiliser Wing
+ cover

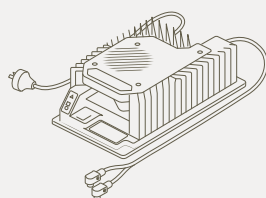

Flitecell Premium
25A Charger

Actual wing choice, mast length and charger type are dependent on your specific configuration.

Box 3: Accessories pouch

Within the included accessories pouch you will find the following components:

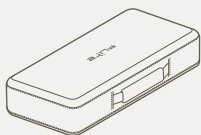

Accessories pouch



Tef-Gel



O-Ring + spare

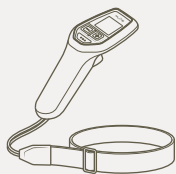

Flite Controller

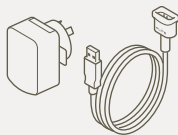

Flite Controller
USB wall charger
and charging cable



Stabiliser Wing shims
6 x styles (0–5)

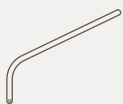

M6 Hex key

M6 x 20mm



M6 x 12mm



M6 x 40mm



M6 x 35mm



M6 x 30mm



M6 x 30mm



M6 x 25mm



XL wing

Cruiser wing

Flyer wing

M6 x 25mm



M6 x 20mm
Front



M6 x 16mm
Back



XL Stabiliser Wing

Stabiliser Wing

Getting started

The best way to learn to Fliteboard is to find a Fliteschool in your area. Locate your nearest Fliteschool at fliteboard.com/fliteschool

Watch the Fliteboard video guides at fliteboard.com/video

In order to operate the product correctly avoiding damage or serious injury it is essential to read and follow all instructions and warnings in the user guide prior to assembly, setup or use.

IT IS BEST TO ASSEMBLE YOUR BOARD IN A CLEAN, DRY ENVIRONMENT.

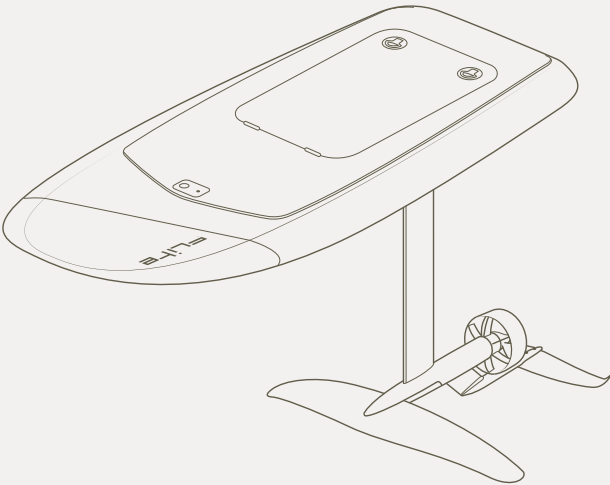

Charging Flite Controller

- 1 Remove Flite Controller from the accessories pouch.
(Located in the eFoil bag).
- 2 Remove Flite Controller USB Wall Charger and Charging Cable from the accessories pouch.
- 3 Carefully peel out the rubber cover on the underside of Flite Controller. Attach the magnetic charging plug, ensuring the charging pins are connected.
- 4 Plug in the USB Wall Charger and turn on. When the Flite Controller is charging correctly, the screen will show a charging message. After a few minutes the screen will hibernate to speed the charging process. Be careful not to disconnect the magnetic charging plug whilst charging. Always check to ensure the Flite Controller is at least 50% charged before each use.

1



2

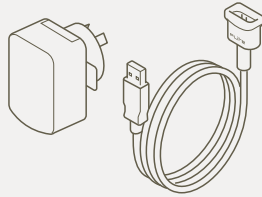

3

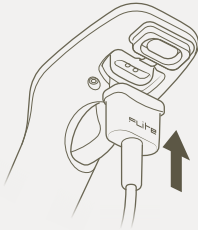

4



Flitecell Charger procedure

DO NOT COVER THE CHARGER OR INTAKE DURING CHARGING. THE CHARGER SHOULD BE PLACED OUT OF THE REACH OF CHILDREN. CHARGE IN AN INDOOR AREA WITH GOOD VENTILATION AND HEAT DISSIPATION.

DO NOT CHARGE IN HUMID, HIGH TEMPERATURE CONDITIONS. DO NOT CHARGE NEAR FLAMMABLES OR EXPLOSIVES. DO NOT DISASSEMBLE THE CHARGER: THERE IS A DANGER OF HIGH VOLTAGE IN THE CHARGER CASE.

FLITEBOARD DOES NOT BEAR ANY RESPONSIBILITY FOR INCORRECT USE OF THE CHARGER. USERS MUST OPERATE THE CHARGER ACCORDING TO THE INSTRUCTION MANUAL.

Flitecell Premium 25A

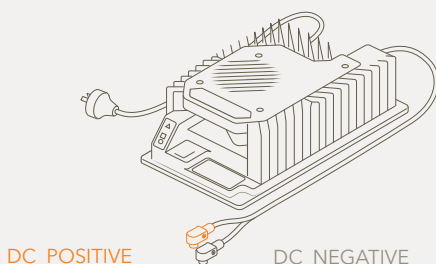

Flitecell Premium 25A Indicator Guide



Power on



Flashing green

Low battery

Solid green

Charging



Flashing green

Charging

Solid green

Fully charged



Solid red

Charger fault

See charger manual



Flashing amber

External error

See charger manual

Charging Flitecell

- 1 Remove Flitecell from its travel bag.
- 2 Place Flitecell in a cool dry location away from flammable or hot items.
- 3 Connect Flitecell charger plugs to Flitecell terminals ensuring to connect the orange (positive) connector to the orange terminal first and the black (negative) connector to the black terminal.
- 4 Check that connections have been made correctly. Plug the charger in the wall socket. A supplied magnet is required to be placed on Flitecell, as shown by arrow, (5-10 seconds) to activate charging. If the magnet has been misplaced, you can use the base of Flite Controller to initiate charging.
- 5 The charger will automatically turn off when the charging process is complete.

FLITECELL IS A POWERFUL BATTERY CONTAINING A SIGNIFICANT AMOUNT OF ENERGY. CHARGING A DAMAGED FLITECELL CAN RESULT IN A FIRE OR EXPLOSION. ALWAYS INSPECT THE FLITECELL BEFORE CHARGING. CHARGE THE FLITECELL UNDER SUPERVISION, IN A SAFE LOCATION, AWAY FROM DIRECT SUNLIGHT, MOISTURE AND AWAY FROM FLAMMABLE OBJECTS AND SURFACES.

THE BATTERY MANAGEMENT SYSTEM (BMS) BALANCES AND OPTIMISES FLITECELL DURING EACH CHARGE CYCLE. IF THE CHARGING MAGNET REMAINS ON FLITECELL AFTER THE CHARGE, THE BMS WILL CONTINUE TO OPTIMISE THE BATTERY WHICH WILL MAXIMISE THE CAPACITY OF FLITECELL. IT IS RECOMMENDED TO LEAVE THE MAGNET ON THE BATTERY FOR AN EXTENDED TIME (12-24H) EVERY FEW CHARGES.

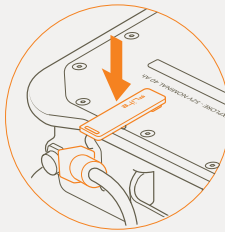
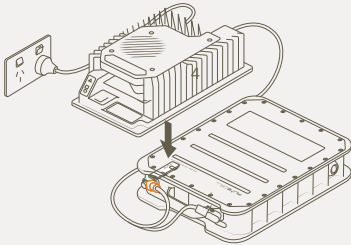

MAGNET
PLACED
TO ACTIVATE
CHARGING

Flitecell light

Light meaning

	<p>Red light flashes</p> <p>Red light on</p>	<p>Capacity 0% – 10%</p> <p>Capacity 10% – 20%</p>
	<p>Green light on</p> <p>Green light flashing</p>	<p>Capacity is 20% - 35%</p> <p>Capacity 0% - 35% + charging</p>
	<p>Two green lights on</p> <p>One on + one flashes</p>	<p>Capacity 35% – 65%</p> <p>Capacity 35% – 65% + charging</p>
	<p>Three green lights on</p> <p>Two on + one flashes</p>	<p>Capacity 65% – 100%</p> <p>Capacity 65% – 100% + charging</p>

Fliteboard AIR assembly

- 1 Unroll Fliteboard AIR bladder face down.
- 2 Place the rigid core (Flitebox cavity side up) on a flat surface.
- 3 Slide bladder onto core from front end first.

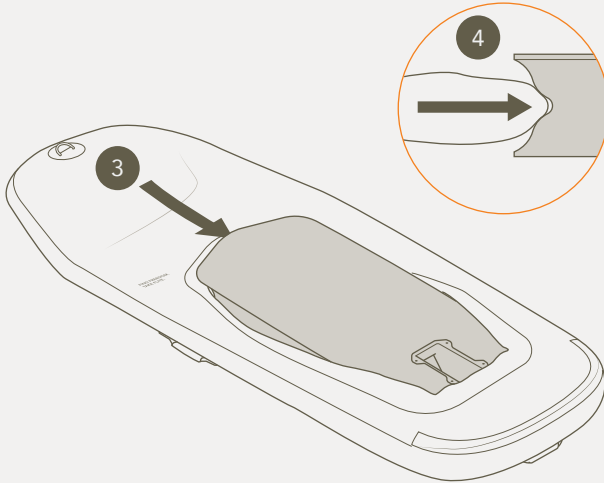

- 4 Ensure bladder is well tucked into the recess along the front edge of the core
- 5 Carefully stretch bladder over one rear corner first. Note that the rear underside edges of the core are deliberately shorter than the top face to make fitment of the bladder easier.

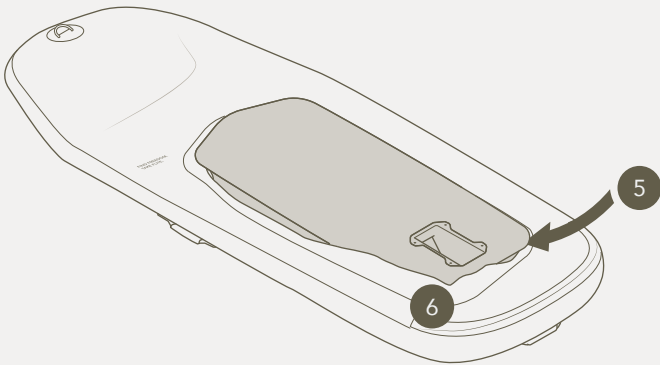

- 6 Stretch the bladder over the last corner. Again, be careful that the bladder is positioned evenly and not creased or caught.
- 7 Check bladder is seated correctly around the core before carefully flipping the Fliteboard Air over.

PLACE ON A SMOOTH, SOFT SURFACE TO AVOID SCRATCHING THE CARBON FINISH ON THE CORE.

WHEN FLIPPING THE FLITEBOARD AIR OVER, BE SURE THAT THE ORANGE O-RING IS SEATED CORRECTLY AND STAYS IN PLACE.

Inflating the Fliteboard AIR

- 1 Twist the valve cap anti-clockwise to remove.
- 2 To inflate, push the central valve down.
- 3 Twist anti-clockwise to release.
- 4 The valve will pop up. This ensures the bladder will not deflate when you remove the hose after inflation.

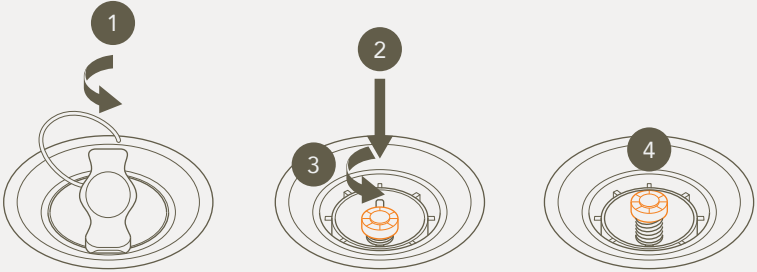

- 5 Connect pump hose to valve and inflate bladder to 18psi.
THIS IS IMPORTANT FOR OPTIMUM PERFORMANCE AND SAFETY.

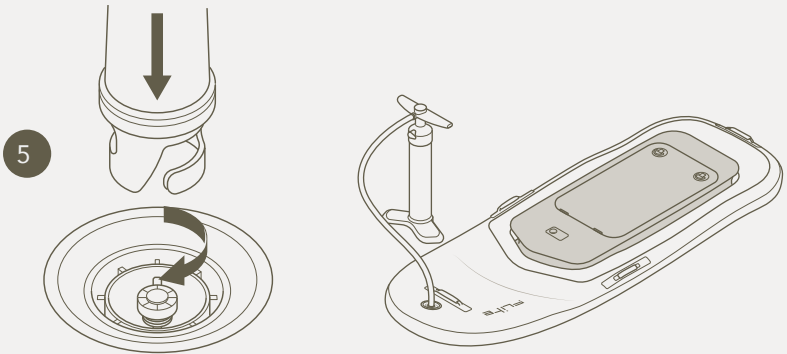

- 6 Once inflated to 18 PSI, twist the pump hose anti-clockwise to remove and re-fit the valve cover cap. When disconnecting the pump hose, no air should escape from the valve. If the bladder deflates you must release the central valve (see step 2) and re-inflate. Fliteboard AIR is now inflated.

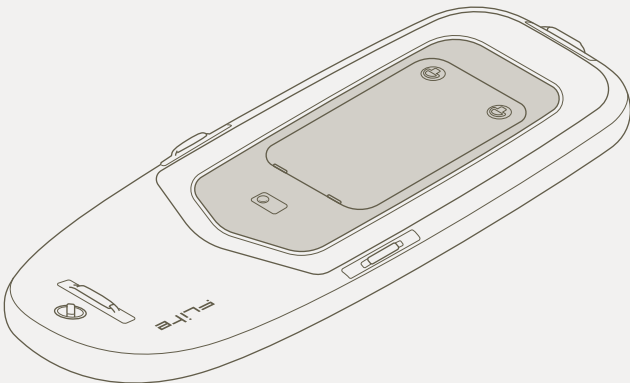

Connect the eFoil to Fliteboard

- 1 Remove the Fliteboard from its bag and place upside down on the bag or other protective surface. Locate the Flitebox cavity on the bottom of the board and ensure the 4 retaining screws are removed.
- 2 Check to ensure the orange o-ring is inserted, properly seated in the Flitebox cavity o-ring groove, clean and free of sand, grit or water.
- 3 Carefully lift the eFoil from its bag and place the Flitebox into the cavity. While doing this ensure the power cables feed through into the Fliteboard cavity.
- 4 Ensure the Flitebox is properly seated in the cavity and flush with the board surface.
- 5 Insert the 4 x 20mm Stainless Steel Hex fasteners. Tighten them in a cross pattern, first using your fingers to ensure the threads are properly engaged, and then using the supplied hex key. Use a torque of 6 Nm to tighten the fasteners.
- 6 Medium force needs to be applied when using the long arm of the hex key to ensure the fasteners are tight.
- 7 When properly tightened, the eFoil should be secured and the o-ring compressed. Failure to properly tighten the fasteners or fit the o-ring will result in a board leak.
- 8 Be careful not to over-tighten the fasteners as this could result in stripped threads or damaged fasteners.

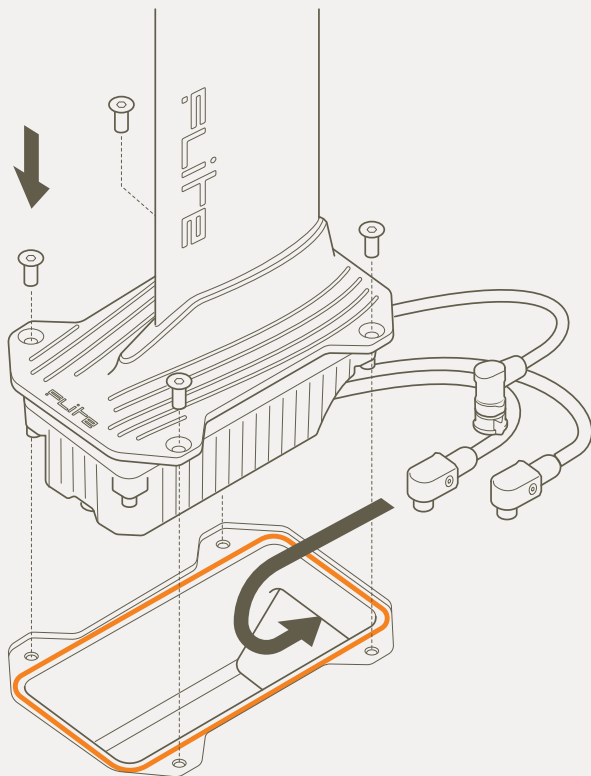

Connect the fuselage tail

- 1 With the board upside down and the eFoil connected, take the 20cm long aluminium fuselage tail from the travel bag and insert into the fin under the propeller guard.
- 2 Add a thin layer of Tef-Gel from the tube supplied to the thread of the supplied 12mm fastener bolt and carefully tighten using the hex key using torque of 6 Nm.



TEF-GEL

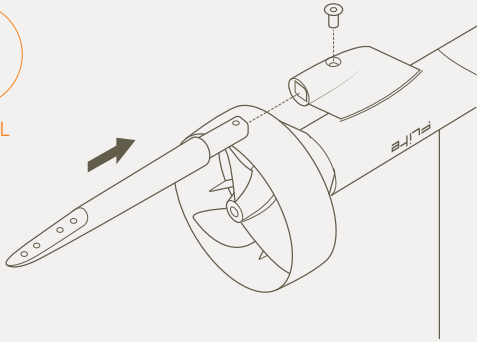

Connect the Wing

- 1 Remove either the XL, Cruiser or Flyer Wing from the travel bag and from its wing cover.
- 2 Place the wing in position as shown.
- 3 Insert the 3 fasteners taking care to ensure the correct set is being used for the particular wing model you are fitting (Refer to page 15). ALWAYS add Tef-Gel to the fasteners first. The fasteners should extend by approximately 6mm through the Wing when placed in the countersunk holes.
- 4 Tighten the fasteners with the supplied hex key, ensuring the fasteners are tight enough that the wing cannot move or wobble significantly during use. Use a torque of 6 Nm to tighten the fasteners.

PRO TIP It's a good idea to add your wing covers first to protect the wing from damage, and also to protect you from the wing's sharp trailing edges.



TEF-GEL

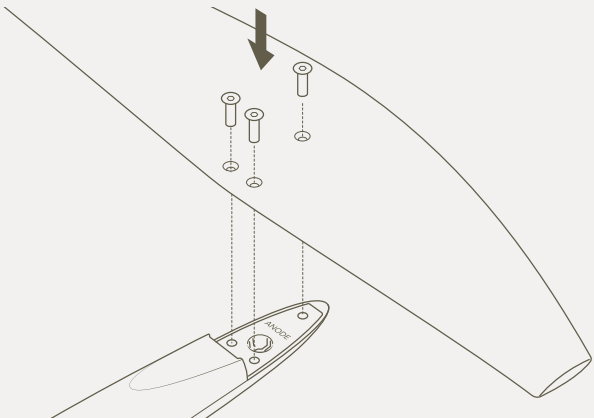

Connect the Stabiliser Wing

- 1 Take the Stabiliser Wing from the travel bag and remove the wing cover.
- 2 Take the correct Stabiliser Wing shim from the accessories pouch and fit between the Stabiliser Wing & the fuselage tail.
- 3 Use a 15mm and 20mm hex fastener to secure the Stabiliser Wing in place.

ALWAYS ADD TEF-GEL TO THE STAINLESS STEEL FASTENERS THAT ARE BEING INSERTED INTO THE ALUMINIUM. IF LEAVING WINGS ATTACHED FOR EXTENDED PERIODS, ENSURE THAT YOU LOOSEN FASTENERS AND RE-APPLY TEF-GEL EVERY FEW WEEKS. FAILURE TO DO SO MAY RESULT IN CORROSION AND DAMAGE TO YOUR EFOIL FASTENER INSERTS.



TEF-GEL

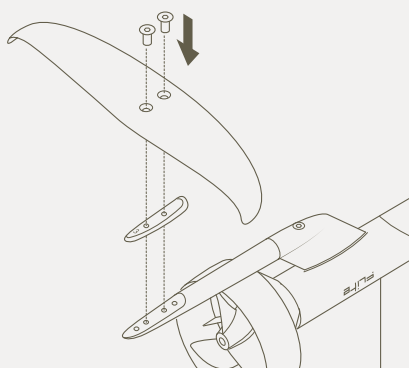

PRO TIP We have supplied 0, 1, 2, 3, 4 and 5 degree shims for you to experiment with to customise your ride. Which shim suits best depends on many aspects such as: preferred riding style, preferred riding speed, riding conditions, skill level and personal preference. Higher shim numbers such as 3 and up, provide early lift at slower speed. However this then requires more front pressure and/or to move feet forward to counter balance. 3 is recommended for "slow" speed turning, less suitable for higher speed, great for longer distance rides. Too high a number will cause the foil to breach the surface. A low shim number such as 0, provides less lift, more agility, easier to achieve higher speeds, and better for tight turns and faster riding, but less stable. However this is for advanced riders, and requires more back foot pressure. It is more difficult to initiate foiling when selecting too low a number.

Connect Flitecell to Fliteboard

With the eFoil, fuselage tail and wings attached, it's time to carefully turn your board over so it stands on BOTH the front wing and nose of the board.

- 1 Twist the Lid Latches and open the board Lid.

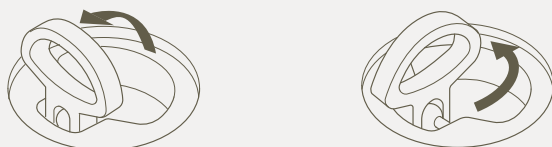

DO NOT OPEN LID WHILST IN THE WATER UNDER ANY CIRCUMSTANCES.

- 2 Locate the data connector coming from the Fliteboard. Carefully connect it to the male connector on the Flitebox ensuring pins align.

DO NOT APPLY ANY FORCE! BE CAREFUL NOT TO TWIST THE CABLE. IF ALIGNED CORRECTLY, NO GREAT FORCE IS REQUIRED.

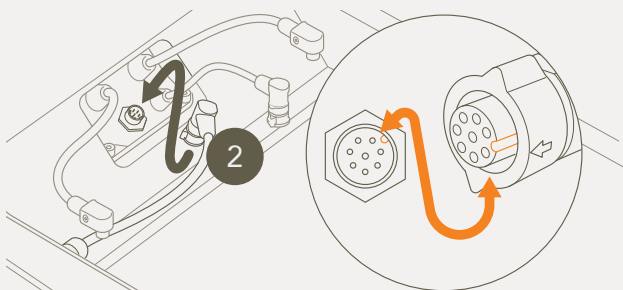

- 3 Take Flitecell by the handle and carefully lower it into the board cavity, ensuring to move cables out of the way first. The warning label should be facing up.

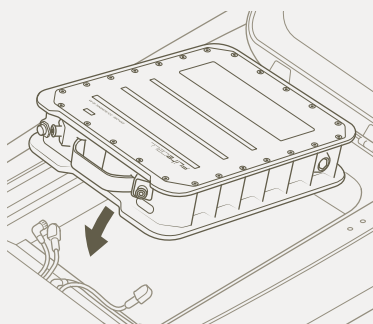

BE CAREFUL NOT TO DAMAGE THE BOARD SEAL WHEN FITTING FLITECELL. ANY KNIKES, CUTS OR DAMAGE TO THE SEAL MAY RESULT IN LEAKS.

BE CAREFUL NOT TO BUMP ANY CONNECTED DATA CABLES WHICH MAY RESULT IN DAMAGE.

BE CAREFUL NOT TO RECONNECT FLITECELL POWER CABLES, WITHIN 10 SECONDS OF DISCONNECTION TO AVOID A POSSIBLE ARC.

- 4 Carefully insert the 2nd data connector (Flitecell) into the socket on the left side of the Flitecell.
- 5 Connect the orange power cable to the orange power in Flitecell. You will feel a secure click when properly engaged.
- 6 Connect the black power cable to the black power in Flitecell.

Flitecell and the data cables are now connected.

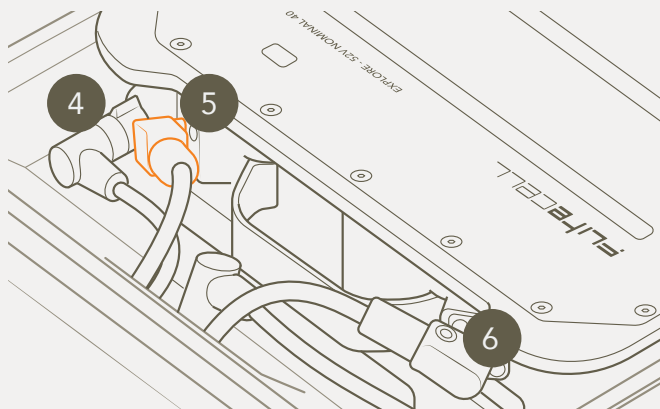

Turning on Fliteboard

- 1 Carefully close the lid. Make certain nothing is caught in the seal.
- 2 Twist and lock the two lid latches.
- 3 A few seconds after the Lid is shut in position, you will hear a **'beep beep beep'** which signifies that the Flitecell and board have automatically turned on.
- 4 If Fliteboard is connected correctly the lid should be securely closed, and a light will be visible on the Receiver located near the front of the board deck grip.
- 5 If the receiver light is not active, open the lid and check that the data and power cables are properly connected.
- 6 Flitecell will automatically turn off 10 seconds after the lid is opened.

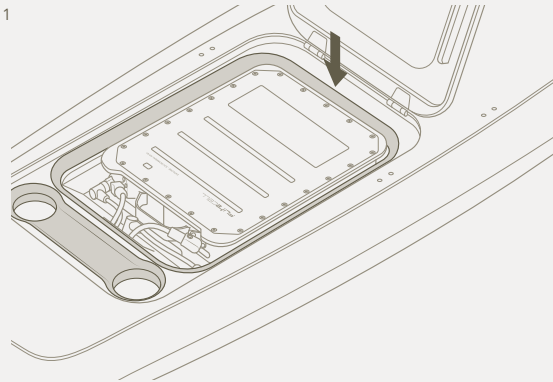

THE SEAL IS A CRITICAL COMPONENT. IF DAMAGED CONTACT YOUR DEALER FOR A REPLACEMENT PART. NEVER RIDE THE BOARD WITH A DAMAGED SEAL.

THE FLITECELL AND CABLES ARE WATER RESISTANT; HOWEVER, ALWAYS KEEP FLITECELL, CABLES AND BOARD CAVITY DRY. WATER, ESPECIALLY SALT WATER, CAN ACCELERATE AGING AND CORROSION. IF YOUR BOARD LEAKS, CHECK SEALS, AND CLEAN COMPONENTS CAREFULLY.

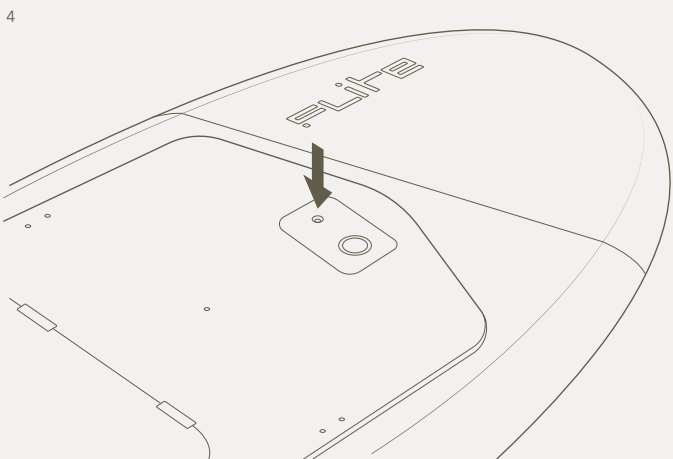

Download Flite App and update

The Flite App is available to download in the Apple App Store*. We recommend using Flite App to ensure your board and controller always have the latest software to deliver the best performance.

*An Android version is in development. If you do not have an iPhone you may get your software updates at one of our Service Centres around the world visit fliteboard.com/locations



Download Flite APP
from App Store
iOS only, V10.7 or higher

[apps.apple.com/
au/app/fliteboard/
id1499441319](https://apps.apple.com/au/app/fliteboard/id1499441319)

Watch our Flite APP
update video

tinyurl.com/yb3vudw8

Performing first update

BEFORE YOU USE FLITE APP FOR THE FIRST TIME MAKE SURE THE PHONE, FLITECELL, FLITE CONTROLLER HAVE AT LEAST 20% CHARGE. KEEP THE PHONE CLOSE AND IN LINE OF SIGHT WITH A STRONG WIFI/CELLULAR NETWORK. DON'T USE THE PHONE FOR ANYTHING ELSE SUCH AS CALLS, TEXTS, OR OTHER APPS.

FLITEBOARD IS READY FOR ITS FIRST UPDATE BY ENSURING THAT IT IS ASSEMBLED AND POWERED ON.

MAKE SURE THE FLITEBOARD LID REMAINS CLOSED DURING THE UPDATE PROCESS.

ENSURE FLITE CONTROLLER IS TURNED OFF AS THE APP CAN ONLY CONNECT TO ONE DEVICE AT A TIME.

Open the app and agree to the onscreen prompts. You'll be taken to the first update process one step at a time. Follow the instructions carefully to update 1. Fliteboard, 2. eFoil and then finally follow instructions to turn on and update the 3. Flite Controller.

The Fliteboard update typically takes 2-3 minutes, eFoil update 2-3 minutes and the Flite Controller 2 minutes.

You may need to wait 10–20 seconds for Fliteboard to restart between Fliteboard and eFoil updates. The Fliteboard LED may switch between flashing blue, solid purple or green.

Connecting Flite App to Fliteboard and the eFoil

- 1 Turn off Flite Controller.
- 2 Ensure Fliteboard has power and the lid is closed.
- 3 Select **'Fliteboard'** from the **'Devices'** menu. When connected, the board receiver LED will turn purple. When performing some updates it will display green.
- 4 You will now be able to see software version of both the Fliteboard and the eFoil.
- 5 Once connected you can perform ongoing updates and now sync session rides under **'Sessions'**

YOU WILL ONLY NEED TO USE FIRST UPDATE PROCESS ONCE. WHEN NEW SOFTWARE UPDATES ARE AVAILABLE, YOU'LL SEE AN ORANGE UPDATE ICON. WHEN UPDATING, DON'T USE THE PHONE FOR ANYTHING ELSE SUCH AS CALLS, TEXTS OR OTHER APPS.



Devices

- 1 Fliteboard is turned on and connectable. New updates are denoted by the orange alert.

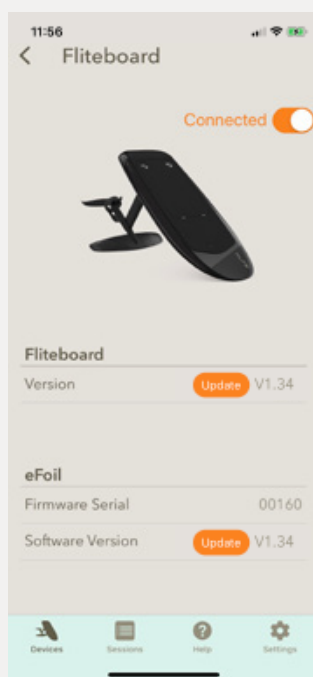

Devices / Fliteboard

Fliteboard is connected. Updates are both required and able to be performed for both Fliteboard and eFoil.

Connecting Flite App to Flite Controller

- 1 Turn off Fliteboard.
- 2 Ensure Flite Controller has power and within range to the phone.
- 3 Select **'Flite Controller'** from the **'Devices'** list. When selected and connected, the current state of charge will be displayed.
- 4 You will now be able to see software version of the Flite Controller and perform any updates here.

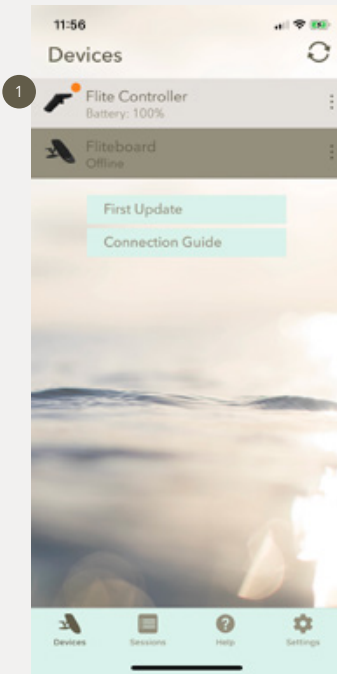

Devices

- 1 Flite Controller is turned on (allowing it to be discoverable in the devices list). Updates are denoted by the orange alert.

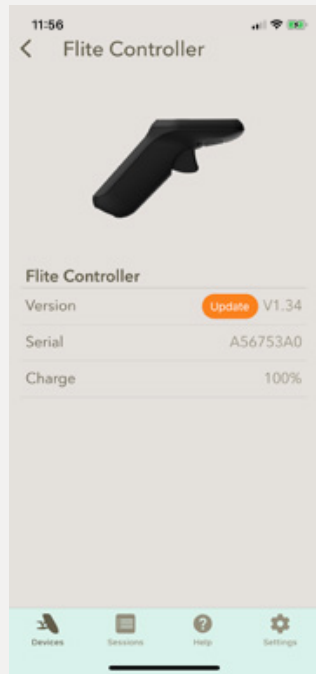

Devices / Flite Controller

Flite Controller is connected. Update by pressing orange 'update' icon.

Capturing sessions

- 1 Once software is up-to-date, Fliteboard will automatically capture sessions to its onboard computer.
- 2 Open Flite App, once ride date has been captured and click on **'Sessions'**. This will display a list of sessions.
- 3 Clicking the share icon (top right) from the **'Sessions'** will share diagnostic data with Fliteboard support via email.
- 4 Clicking a ride in the Sessions list, will then take you to ride detail screen. Here you can play back your ride in various speeds, over an aerial map.

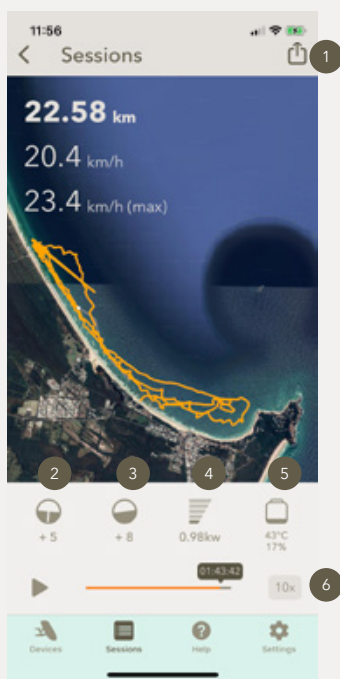
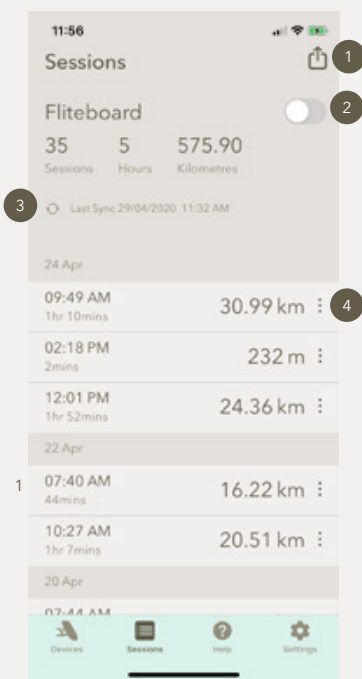

Sessions

- 1 Share diagnostics with support
- 2 Connect / disconnect (when powered and in range)
- 3 Sync sessions (when Fliteboard is connected)
- 4 Session ride (swipe left to rename)

Sessions / Ride detail

- 1 Share ride
- 2 Ride roll angle
- 3 Ride pitch angle
- 4 Power consumption
- 5 Flitecell temperature displayed in celsius. Flitecell charge remaining
- 6 Adjust ride playback speed

Flite Controller overview



Turn on and connect Flite Controller

- 1 Turn on Flite Controller by holding down the + button AND Mode (bottom) button together for 3 seconds.
- 2 After a 3 second press of both buttons, the Flite logo will appear with the software version number, and the Controller will move to the home screen with lock icon.

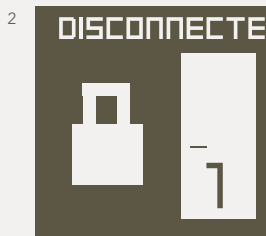
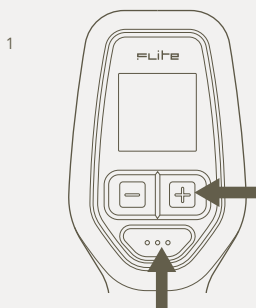

Flite Controller disconnected (requires pairing) and motor locked (requires arming).
Power Level 1 (Gear 1).

Hold + button for 5 secs to put into pairing mode.

IF THE RECEIVER HAS A LIGHT BLUE SOLID LIGHT (NOT BLINKING) YOUR FLITE CONTROLLER IS CONNECTED. IF THE RECEIVER LIGHT IS FLASHING YOUR CONTROLLER AND FLITEBOARD NEED TO BE PAIRED.

Flite Controller screen guide

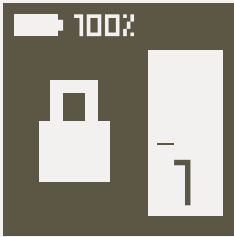

Motor locked

Ready to arm.
Flitecell 100% charged.
Power Level set to level 1.

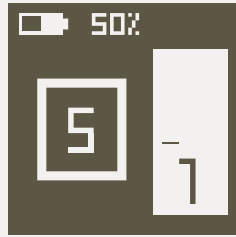

Motor armed

Motor unlocked with 5
seconds to squeeze the
throttle trigger.
Flitecell charge 50%

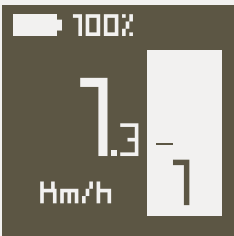

Current Speed / Power

Speed 1.3 Km/h
Power level 1



Distance

Traveled 6.4 kms
Remaining 24.7 kms
Current Speed 23.6 Km/h

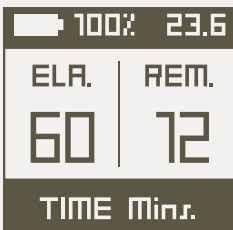

Time

Elapsed 60mins
Remaining 12mins
Current speed 23.6 Km/h



Speed

Maximum 35.1 Km/h
Average 13.2 Km/h
Current speed 23.6 Km/h

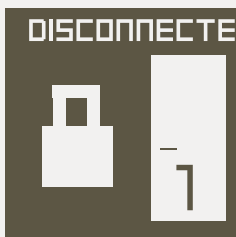

Disconnected (scrolling)

Flite Controller is not paired or under water. Hold plus for 5 seconds until Flite Controller displays



Looking for new pair (scrolling)

Flite Controller is looking for a new pair. Hold over arming pad for 10 seconds to complete the pairing process.



Diagnostics

Flitecell kilowatts 1.5
 Prop RPM x 1000 = 2,100
 ESC Temp 40 Degrees
 Flitecell Temp 40 Degrees
 Flitecell Charge 100%
 Current Speed 23.6 Km/h



Efficiency

60 Wh/km
 Flitecell charge 100%
 Current speed 23.6km/h



Charge remaining

Flitecell 98%
 Flite Controller 66%

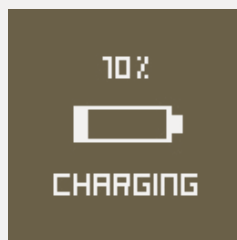

Flite Controller charging

Flite Controller currently at 10% state of charge

Flite Controller screen guide



50% Flitecell warning

Flitecell has 50% (or less) remaining charge.

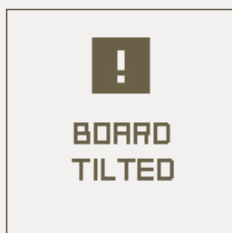

Fliteboard tilted

Fliteboard is disabled due to the tilt angle.

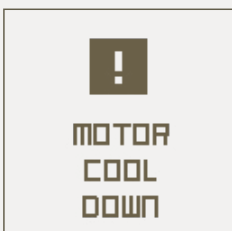

Motor Cool Down

The motor has overheated. Fliteboard is limited to low gears for 1 minute to allow motor to cool.

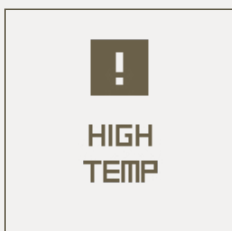

High Temp

Flitecell is too hot. Ride using low power to allow Flitecell to cool, otherwise Flitecell may shut down.



Flitecell charge critical

Flitecell charge very low, immediately return to shore. Fliteboard is limited to low gears only to conserve charge.

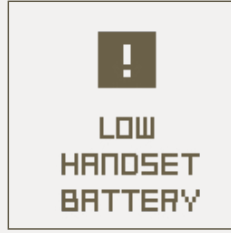

Flite Controller low charge

Flite Controller requires charge. Ensure Flite Controller is charged above 50% each ride.

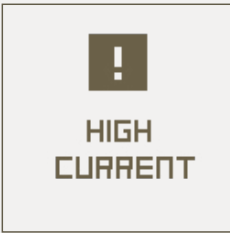

High Current

Fliteboard current is too high. Reduce power to avoid motor damage.

Pairing Flite Controller with Fliteboard receiver





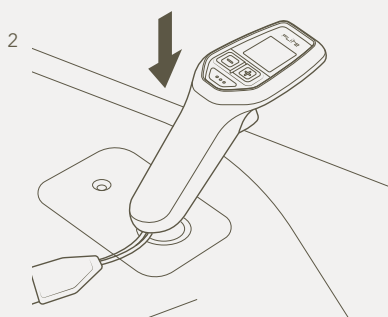
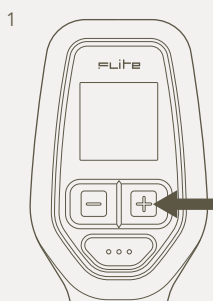



- 1 Hold the + button for 5 seconds until the words '**Looking for new pair**' appear on the screen.
- 2 Place and hold the base of Flite Controller on the arming pad on the board receiver (same position for pairing and arming). The light blue LED should be flashing on the receiver.
- 3 Hold this position for 10 seconds at least or until paired. Fliteboard will be paired when you see three quick successive light blue flashes from the receiver and then a solid light. The Flite Controller will now display the Flitecell percentage instead of 'looking for new pair.'

DO NOT HOLD THE FLITE CONTROLLER IN THE ARMING POSITION FOR LONGER THAN NECESSARY. A **20 SECOND HOLD** WILL PUT THE BOARD INTO SOFTWARE UPDATE MODE REQUIRING THE BOARD TO BE RESET BY DISCONNECTING FLITECELL POWER LEADS AND RECONNECTING.



Receiver light

Flite Controller meaning

	LIGHT BLUE FLASHING	Needs to be paired
	LIGHT BLUE SOLID	Successfully paired
	DARK BLUE TEMPORARY	In contact with arming pad
	DARK BLUE FLASHING	Countdown to unlock motor / arm
	DARK BLUE SOLID	Trigger engaged
	GREEN SOLID	Diagnostic mode
	GREEN FLASHING	Receiver startup/reset
	PURPLE SOLID	Flite App connected

Arming the motor

Fliteboard uses a safety lock to guarantee that riders cannot accidentally spin the propeller by bumping the throttle trigger unintentionally. Riders must arm (unlock) the motor to Fliteboard.

- 1 To unlock the motor place the butt of Flite Controller over the arming pad on the board receiver. The light will flash dark blue when the position is correct. The lock icon on the Flite Controller display will be replaced with a 5 second countdown. The motor is now armed.
- 2 Pull the throttle trigger within the 5 second countdown window to activate the propeller. ALWAYS verify the propeller is clear and in a safe location before activating the motor.
- 3 You can activate the motor on land to test the function of the Fliteboard, however you MUST ensure that no one is near the propellor during testing.

NEVER RUN THE MOTOR OUT OF WATER FOR MORE THAN 3 SECONDS, AS DOING SO CAN OVERHEAT AND DAMAGE THE PROPELLER SHAFT AND SEALS.

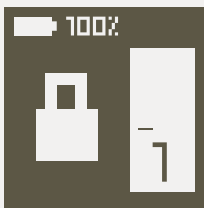
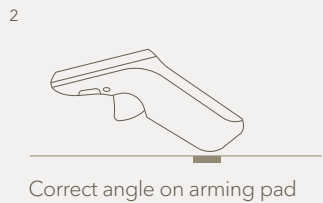
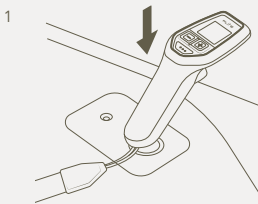

Motor locked



Motor unlocked and armed with 5 seconds to squeeze throttle trigger

PRO TIP Be careful not to hold the Flite Controller over the arming pad for too long. Holding this position for 20 seconds will cause the receiver to disconnect from the Flite Controller and search for a new pair. As soon as the controller has been unlocked, move it away from the pad.

Get Fliteboarding

Fliteboard recommends that first time riders have at least one lesson with a certified Fliteschool.

Select a suitable riding location

A location with deep enough water is essential. The Wings and eFoil should never make contact with anything below the surface, including a sand bottom. Be aware of tide times, as well as submerged items such as branches, coral, boat chains and fishing lines. If you are unsure about the local area ask someone who knows the waterway for advice. Be aware the board can be submerged with rider weight, reducing clearance required.

Choose a location away from swimmers and other water users and ensure local laws allow motorised craft to be used in the area.

Learning to Fliteboard in very smooth water without waves or strong currents is SIGNIFICANTLY easier and safer than learning in choppy water. Your first Fliteboard experience will be challenging (but rewarding) so choose a location and weather conditions that allow for the easiest possible learning experience.

Ride time and range are dependent upon:

- Rider weight
- Average speed
- Wing choice
- Water / wind conditions

ENSURING SAFE WATER DEPTH IS EXTREMELY IMPORTANT BEFORE RIDING. SELECT A LOCATION THAT IS HAS A MINIMUM DEPTH OF AT LEAST 1.5 METRES.

ALWAYS MONITOR FLITECELL LEVELS WHILE RIDING AND TAKE CARE NOT TO DEplete THE FLITECELL BEFORE RETURNING TO YOUR POINT OF ORIGIN.

NEVER RIDE FLITEBOARD FURTHER FROM SHORE THAN YOU ARE PREPARED TO SWIM BACK.

Arm Flite Controller

- 1 Before taking your board to the water, first test out arming Flite Controller.
- 2 Turn on Flite Controller by holding the bottom (mode) button and the top right (+) button for 3 seconds.
- 3 The motor can become active once the remote is paired so it is best to do this in the water. You are now ready to launch in a water depth of at least 1.5 meters.
- 4 Unlock the motor, place the butt of Flite Controller over arming pad on the board receiver. The light will turn dark blue when the position is correct, and the lock icon on the board will be replaced with a 5 second countdown.
- 5 As soon as it unlocks, immediately move the controller away from the arming pad, and gently squeeze the throttle. Push for 1 -3 seconds to check connection and function of the prop only.

2

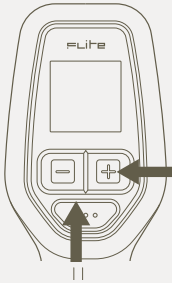

4

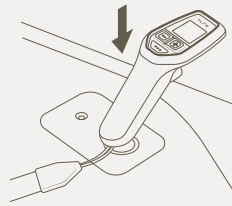

Engage the Motor and get moving

- 1 Climb onto the board, taking care not to kick the hydrofoil wings or mast.
- 2 Lie on the board, positioned so that you can touch the front of the Fliteboard with your hand (or the front handle if using the Fliteboard AIR).
- 3 Verify Flite Controller is set so you see power level '1' displayed on the lock screen. This is your starting power setting once unlocked (it can be changed later if you are an advanced rider).
- 4 Arm the motor and squeeze the throttle trigger. The board should start to move. You should be on power level 1 (a low power setting).
- 5 Practice riding lying on the board and changing speed using the buttons between level 1 and level 3. Be sure to keep enough weight on the front of the board to keep the nose of the board down and parallel to the water.

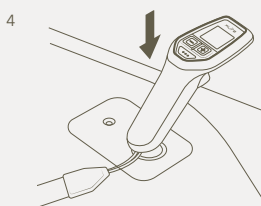
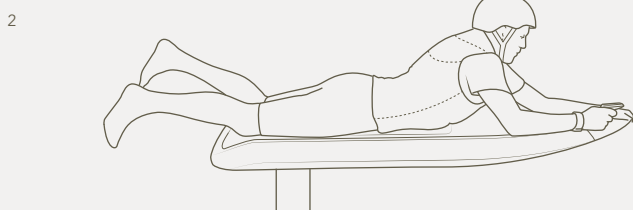
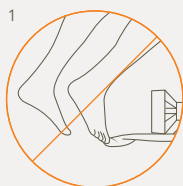

PRO TIP Fliteboard has been designed with a cruise control system in mind. Squeezing the trigger all the way in makes it easier to use your thumb to change the speed (from level 1 to 20). As you accelerate you may need to shuffle forward to keep the nose down.

Getting to your knees

- 1 Once comfortable lying on the board, arming the motor, changing speed and riding the board lying down, it's time to get to your knees.
- 2 Depending on your weight, board and conditions, you may wish to move to your knees on power level 3, 4, 5 or 6. You want to be traveling fast enough that you won't nose dive or sink, but not so fast that you are bouncing over chop, planing quickly or starting to foil. A speed of 6-8 kph on the GPS display on the Flite Controller is a good speed for getting to your knees.
- 3 Place both hands on the board, smoothly push your body up and slide both knees under you onto the board. Your knees should be positioned just in front of the lid hinges. Be careful not to put your knees on the hinges themselves.
- 4 Keep your body weight forward to keep the nose down and the foil disengaged.

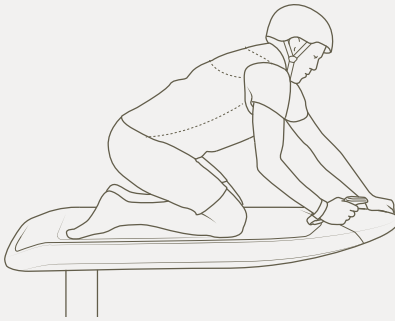

2



PRO TIP Be careful not to let go of the throttle trigger as you move to your knees. You should practice maintaining a constant speed when changing body positions on the board.

Once you feel ready, you can practice starting to foil on your knees by carefully moving your head and upper body back. As soon as you hear the noise change from the board leaving the water, shift weight forward again to level off the foil or to touch down again.

Standing up

Check that you have clear flat water in front of you with no obstacles or other vessels.

Select a speed where the board feels stable. The ideal speed depends on your weight and board choice, but between 8kph and 12kph is a good speed to stand up.

- 1 While being careful not to let go of the throttle trigger (so you maintain a constant speed) place your front foot in the space in front of your knees. Your toes should be near the front of the foot pad and slightly to one side. (Refer to the diagram in the below PRO TIP)

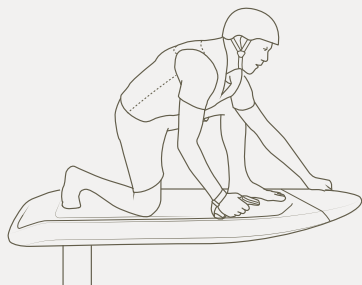

- 2 Take a moment to get your balance. Then, stand up, with as much weight as possible pushing through your front foot. This should feel like standing from a lunge position. Keeping your weight on your front foot keeps the board and nose down, which in turn keeps the foil in the water. Standing up with weight on your rear foot can result in the foil engaging and then an unintended crash.
- 3 Once standing keep your weight forward over your front knee. Your chest and nose should be lined up with, or in front of your front knee.

PRO TIP The ideal body position is with your body twisted forward, with front foot just behind the front of the deck grip, and rear foot 10cm in front of the latches, with both feet hip width apart. This stance is similar to the 'Warrior One' Yoga stance. This riding stance keeps your weight forward allowing good control over the pitching of the board forward, aft, left and right.

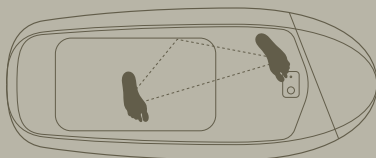

- 4 Once standing, practice slowly adding speed, but always while pushing down hard through your front leg. The foil, motor and your own bow wave will want to push the nose up. Push down hard and practice accelerating to planing speed, with the board flat on the water. Taking your weight off your front foot will engage the foil and likely result in a crash until you have learned to balance the foil.

Foiling for the first time

Like learning to ride a bike for the first time, learning to foil is challenging as it requires your brain to learn a new way to balance. There is also potential for you to fall on the Wings if not careful. Wear appropriate safety equipment including a Helmet and PFD, take your time and follow these steps.

Once comfortable standing at medium speeds, practice going faster with as much weight as possible over your front foot. Unlike surfing, you control the board more with your front foot. Weight on your front foot with your body leaning forward is safe - as it keeps the foil in the water. Whenever you become uncomfortable, lean forward toward the nose of the board. This will ensure the board is on the water and stable.

- 1 Practice standing in the riders stance and gradually increase your speed. The initial goal is to be able to ride at safe foiling speed (so you are in control and still within local laws) with the board still on the water. You do this by keeping your weight forward.
- 2 While planing at the correct speed with your feet in the correct position and the board LEVEL on the water; very gradually start to transfer weight backwards. You will feel slightly less pressure on your front foot and more pressure on the back foot. Do this carefully, with your weight over the centre line of the board and your core engaged.
- 3 As soon as you feel the board leave the water (you will hear the noise change) lean forward again and touch down. The goal is to foil as LOW as possible for very short sections. Foiling for 5 meters at a time and then touching down again is all you need to do.

Practice this and your brain will work out the rest. Before long you will be foiling for longer periods and then continuously.



Don't go too high.



More pressure on front foot

PRO TIP The safest and easiest way to learn to foil is to foil low and practice repeated touch and go's. As you foil higher you expose yourself to the risk of a crash where you could hit the wings. You may lose your confidence and learning will take longer.

Foiling pro tips

If you shift your weight too far to one side, it is not possible to recover. Jump away from the board in the direction you are falling. This takes you SAFELY away from the foil.

Keep your weight forward and press down through your front knee. Confirm your feet are in the correct position.

Don't vary your speed, it will only unsettle the foil and make balance harder. Like an aeroplane, the foil wings need a constant speed for smooth flying.

Don't try to foil going too slow. The wings will stall and you will crash.

Don't try to turn on the foil until you are very comfortable in a straight line.

Keep the board flat and level.

Foiling through turns

Turning while foiling requires careful balance on all axes.

Start by doing very wide turns.

As you gain experience you can try tighter turns.

Keep speed constant.

In tight turns you will need to apply more force to your back leg to maintain foil altitude (like an aeroplane adding elevator through a turn).

All of this might sound complex, but if you keep your weight forward, practice in flat water, maintain constant speed, and take learning step by step, you will likely be foiling in no time.

Storage & maintenance

Read through the entire storage and maintenance instructions before storing your board.

Fliteboard

Post ride

Open the board lid slowly, take care not to let it fall on the nose of the board. (Don't leave the lid open too far, as the lid may fall and damage the nose of the board).

After each ride, check to see if any water has leaked into the battery cavity.

If so, check the cause of the leak which may include: sand present on the sealing surface; a damaged or dislocated seal; damaged hinges or latches; or something obstructing the lid when closed.

Carefully clean the board cavity and the battery with fresh water and a cloth and then dry thoroughly.

Carefully wipe the seal down to remove any sand or salt.

Clean the data connector contacts with contact cleaner if they have been exposed to moisture.

Regular maintenance

Apply lubricant / WD40 to the latches and hinges every few weeks. Keep the lubricant away from the deck grip to avoid a slippery board.

Check the board regularly for damage or cracks. If damage is present have it repaired by a professional surfboard or sailboard repairer.

Storage

Remove any sand, dirt or salt water.

Ensure the board and deck grip are dry before storage.

Take extra care not to scratch the carbon board bottom and wings.

Place your Fliteboard in the provided bag, then store in a clean and dry environment.

Keep the board and bag out of the sun.

DURING STORAGE, IF POSSIBLE, KEEP THE EFOIL ATTACHED TO THE BOARD AND THE FLITEBOX DATA-CONNECTOR CONNECTED. THIS WILL KEEP THE CONNECTOR PINS SAFE FROM WATER, SALT, SAND, AND CORROSION.

Fliteboard AIR

Post ride

Wash the inflatable bladder with warm soapy water and dry before storage.

The inflatable bladder can remain inflated, or be deflated and stored on or off the carbon insert to suit your storage preference.

Regular maintenance

The inflatable bladder can be repaired using the supplied repair kit. 18 psi is the recommended inflation pressure.

eFoil

Post ride

Disconnect the Flitecell power and data cable.

Rinse thoroughly with clean fresh water after every use.

Rinse the inside of the mast (through the notch in the rear of the flange) with fresh water.

Rinse around the mast flange to wash salt away from the board connection area (if keeping the board and foil attached).

Regular maintenance

Disassemble the eFoil from the board.

Remove the wing, fuselage cover and tail, and clean thoroughly with fresh soapy water to remove any built-up salt or sand.

Apply Tef-gel at least once every few weeks to all removable bolts and threads.

Clean the eFoil data connectors with contact cleaner.

Storage

Always store the eFoil in a clean, dry environment.

Flite Controller

Post ride

Rinse the Flite Controller in fresh water to clean away salt and debris.

Storage

Store in a cool dry place, out of the sun.

Flitecell

Post ride

Wipe Flitecell down with a wet cloth (freshwater), and clean Flitecell contacts and data connector with contact cleaner.

Flitecell is water resistant but it should remain dry where possible. DO NOT submerge or shower.

Avoid placing Flitecell on the sand, which can make its way into the battery cavity and scratch surfaces.

DO NOT charge the Flitecell immediately after use. The Flitecell temperature may be too high. Allow 30 mins between riding and charging to allow for cooling.

DO NOT clean the battery or charger with denatured alcohol or other flammable solvents.

IF THE BOARD HAS LEAKED AND / OR THE BATTERY HAS BEEN SUBMERGED IN WATER, INSPECT FOR WATER INGRESS USING THE SIGHT GLASS LOCATED ON THE SIDE OF THE BATTERY. STAND THE BATTERY UP ON ITS BOTTOM END FOR ONE MINUTE AND THEN PLACE THE BATTERY ON ITS SIDE WITH THE SIGHT GLASS FACING DOWN FOR ONE MINUTE. INSIDE THE SIGHTGLASS IS A COLOUR CHANGING LABEL WHICH WILL TURN RED IF WATER IS PRESENT. INSPECT THE SIGHT GLASS AND CONFIRM THAT WATER IS NOT PRESENT BEFORE CHARGING AND USING A BATTERY THAT HAS BEEN IMMersed IN WATER.

IF A BATTERY HAS BEEN DROPPED OR DAMAGED, CONTACT FLITEBOARD IMMEDIATELY AND DO NOT USE THE BATTERY.

Regular maintenance

Examine the charger regularly for damage to the cord, plug, enclosure or other parts.

Storage

Keep Flitecell stored out of the reach of children and pets.

DO NOT store the Flitecell near heat sources such as a furnace or heater. DO NOT leave the Flitecell inside of a vehicle on hot days. The ideal storage temperature is 22°C-28°C.

Do NOT store the Flitecell whilst charging. Disconnect the charger when not in use.

DO NOT store the Flitecell fully charged or discharged for a longer period of time.

For long term storage a charge state of 75% (2 LED on) is optimal.

Shipping and transport

Flitecell (batteries) are considered a dangerous good and must not be shipped without working with a dangerous goods shipping specialist. Shipping batteries marked as normal goods without informing the shipping party is illegal and dangerous. The Material Safety Data Sheet (MSDS) is required for shipping the batteries.

Issue Troubleshooting guide

Fliteboard starts to slow or 'limp'	This is a sign your Flitecell is about to run down or over heat. Move out of the water and recharge your Flitecell. Refer to the Flitecell charging instructions.
Fliteboard turns off while riding	Move out of the water to a safe, dry, clean area. Check the LED on Flitecell to confirm if it still has charge. If it has charge, disconnect and reconnect the Flitecell to see if you can establish a connection. Inspect the Flitecell for water or damage. There should be no water inside the Flitecell housing.
Flite Controller disconnects	Re-arm the Flite Controller. See arming instructions.
Flite Controller unpairs	Re-pair the Flite Controller. See pairing instructions.
Flitecell charger won't connect	Disconnect and reconnect. Contact Fliteboard Customer Support.
Flite Controller won't turn on	Ensure Flite Controller is fully charged. See Flite Controller charging instructions.
Flite Controller shows a battery warning	Slow down or decrease power consumption to cool the Flitecell down. The Flite Controller will warn you when the Flitecell temperature reaches 55°C and again at 60°C. At 65°C the Flitecell will automatically start to shut down to preserve itself.
Water in the Fliteboard cavity	Remove the board from the water. Remove the Flitecell. Dry the board completely. Check the Flitecell for leaks. If the Flitecell has taken in water refer to the section below. Once dried and re-assembled, take care that the Fliteboard Cavity Seal is properly compressed when closing the Fliteboard Lid.
Water in Flitecell	Flitecell has an indicator for water damage. If water has penetrated the casing, regularly check the circular water indicator on the side of your Flitecell. If the sticker has turned red, this means water has penetrated the housing. IF WATER HAS PENETRATED THE FLITECELL, PLEASE SET FLITECELL ASIDE IN A COOL DRY PLACE. DO NOT ATTEMPT TO USE A FLITECELL THAT HAS BEEN WATERLOGGED. CONTACT FLITEBOARD IMMEDIATELY.
Unable to pair Flite Controller	Please ensure the Fliteboard Lid is fully closed before pairing
Unable to pair Flite Controllers to multiple boards	Do not attempt to pair multiple Flite Controllers to multiple Fliteboards simultaneously. Always pair one at a time.
Reduced runtime	The battery management system (BMS) balances and optimises the battery during each charge cycle. Leave the charging magnet on Flitecell for 24-48 hours after the charge to allow the BMS to optimise Flitecell.

Technical Specifications

Speed	Up to 45 kph / 28 mph
Tested load range	100 kg / 220 lbs
Run time 85 kg rider	Up to 1 hr 20 min (Flitecell Explore)

Board details	KG	MM	L
Fliteboard PRO	9.95	1550 L x 600 W x 110 D	70
Fliteboard	11.85	1735 L x 650 W x 125 D	100
Fliteboard AIR	11.85	1930 L x 770 W x 135 D	175

Fliteboard & Fliteboard PRO

Materials	Carbon Fibre, Innegra, aircraft grade aluminium, high quality wood laminates and composites.
------------------	----------------------------------------------------------------------------------------------

Fliteboard AIR materials

Type	Inflatable
Materials	Grey Selytech Composite Super Light Drop Stitch Fabric / PVC / EVA
Pressure	18 PSI

Travel case

Fliteboard PRO	1630 X 700 X 170mm
Fliteboard	1800 x 760 x 170mm
Fliteboard AIR	600 x 1220 x 300mm
eFoil case	1100 x 640 x 260mm
Flitecell travel bag	510 x 40 x 190mm

eFoil system

Input power	5,000 Watts
Max output power at shaft	3,700 Watts
Nominal voltage	52v
Maximum current	100 AMPS
Motor type	Brushless
Motor speed	4500 rpm propeller peak
Protections	Overheating, overcurrent
Propeller diameter	142mm
Propeller guard	155mm

Flite Controller

Communication Type	Bluetooth
Speed Control	20 step display
Runtime	Average charge 24 hrs / Standby 200 hrs
Rated cycles	1000 charge cycles
Protection grade	IP67

Fast 20A Charger

Charging current	20 AMP
Charge time	Less than 2 hrs

Premium 25A Charger

Charging current	25 AMP
Charge time	1hr 45min Flitecell Explore 1hr 15min Flitecell Sport

Flitecell Sport

Size	315mm x 305mm x 80mm
Capacity	30Ah / 1.5KWh
Weight	10kg
Protection	IP67
Max charge voltage	58.8v
Min voltage	42v
Nominal voltage	52v
Rated continuous discharge current	100a
Rated charge current	25a
Rated cycles >80% capacity	400 Cycles
Temperature discharge limits	10-70 Degrees C
Temperature charge limits	10-50 Degrees C
Communication	CANBus Protocol 2.0b
BMS critical functions	Balancing, Over-temperature (Charge/Discharge) Over-current, short-circuit protection, reverse polarity and over & under voltage
Other safety	3 levels of fusing adds redundancy if BMS failure occurs. Conformal / Resin coatings used on PCB's and Cells (UL94-0)

Flitecell Explore

Size	390mm x 305mm x 80mm
Capacity	40Ah / 2.1KWh
Weight	13.9kg
Protection	IP67
Max charge voltage	58.8v
Min voltage	42v
Nominal voltage	52v
Rated continuous discharge current	100a
Rated charge current	25a
Rated cycles >80% capacity	400 Cycles
Temperature discharge limits	10-70 Degrees C
Temperature charge limits	10-50 Degrees C
Communication	CANBus Protocol 2.0b
BMS critical functions	Balancing, Over-temperature (Charge / Discharge) Over-current, short-circuit protection, reverse polarity and over & under voltage
Other safety	3 levels of fusing adds redundancy if BMS failure occurs. Conformal /resin coatings used on PCB's and cells (UL94-0)

